

## Development of Tether Mooring Type Underwater Robot

Ya-Wen Huang\*, Koji Ueda\*, Kazuhiro Itoh\*\*, Edwardo F. Fukushima\*, Shigeo Hirose\*

**Abstract**—For the purpose of detecting CO<sub>2</sub> leaks during ocean CO<sub>2</sub> sequestration, there is a need for independent underwater robots that can make observations while maintaining their position over the seabed against the current for long periods of time. In order to achieve this objective, a novel tether mooring type underwater robot was proposed. The robot is moored and its position is controlled by changing the length of the tether. In addition, it can sustain itself with a sea current power generation system. After that, the prototype underwater robot “Anchor Diver” was developed. Anchor Diver is moored by one tether, moves using horizontal and vertical rudders and moves upstream by reel mechanism. In addition, the use of a movable anchor and generator as a propeller enables Anchor Diver to enlarge its range of activity. This paper describes the detailed development of Anchor Diver and underwater experiments.

### I. INTRODUCTION

Recently, there are great concerns that increasing CO<sub>2</sub> is the main cause of global warming effects. One of the solutions is to sequester CO<sub>2</sub> in depleted undersea oilfields under continental-shelf floors [1]. However, if fissures in the seabed cause the CO<sub>2</sub> to leak to the surrounding ocean area, there is a possibility that the ocean will become acidified bringing harmful effects to the ecological system [2]. Therefore, an underwater robot for detecting CO<sub>2</sub> leakage is necessary, which can stay near the seabed against the sea current for a long time.

For existing underwater robots, it is necessary for most of them to receive control commands and their energy supply

Manuscript received March 1, 2009.

This research was supported by The Grant-in Aid for 21st Century COE Program by The Ministry of Education, Culture, Sports, Science and Technology.

\* Dept. Mechanical and Aerospace Engineering, Tokyo Institute of Technology, Ohokayama Meguro, 152-8552, Japan  
Phone/Fax: +81-03-5734-2648

huang@robotics.mes.titech.ac.jp; ueda@robotics.mes.titech.ac.jp;  
fukushima@mes.titech.ac.jp; hirose@robotics.mes.titech.ac.jp

\*\* Hitachi Construction Machinery Co., Ltd.

650, Kandatsu-machi, Tsuchiura-shi, Ibaraki-ken 300-0013 Japan  
k.itou.xb@hitachi-kenki.com

from mother ships that consume a great amount of money, for example traditional Remotely Operated Vehicle (ROV).

Additionally, it is thought that without mother ships on the ocean, long-term, continuous activities of underwater robots will be difficult to realize. On the other hand, for general Autonomous Underwater Vehicles (AUV), the thruster has to be driven all the time to maintain its position against ocean currents which depletes its limited built-in power source. In this case, it is difficult for an AUV to operate for long durations.

As an alternative, seabed stations which are installed on the seafloor can perform fixed-point observations, but one seabed station can only stay at one fixed place so that the system needs a lot of stations to carry out an area survey.

Therefore, it is difficult to achieve the long-term, wide area survey independently by using general underwater vehicles. The new concept of underwater robot “Anchor Diver” is developed for this kind of application.

### II. PROPOSAL OF TETHER MOORING TYPE UNDERWATER ROBOT

The concept of the new underwater robot is to moor the body to the seabed by tether and to move in the water by changing the length of the tether using a reel mechanism [3]. An on-board sea current power generation mechanism provides power for the robot's operations. This type of tether-mooring underwater robot can be divided into several categories.

#### A. Categories of Tether Mooring Type Underwater Robots

Tether mooring type underwater robots can be broadly divided by the number of tethers for mooring: those which are single tether type and multiple tether type. Single tether type underwater robots (shown in Figure 1) are moored by a single tether which is controlled by changing the length of the tether and adjusting the angle of the rudders. On the other hand, an example of the multiple tether type is the 3 tether type robot shown in Figure 2; the balance of the buoyancy and the tension on the multiple tethers maintains

the robot's stability. The multiple tether type robot controls its position by changing the length of each tether, making 3D movement possible.

Furthermore, according to the type of mooring anchor, tether mooring type underwater robots can be divided into three types: fixed anchor, movable anchor, and robot anchor (Figure 3). For fixed anchor, after the anchor is deployed, the position of the underwater robot is fixed throughout the mission. On the contrary, the adjustable prongs of a movable anchor allow it to be pulled back and relocated, which expands the range of activities of the underwater robot (Figure 4).

However, when movable anchors are combined with multiple tethers, due to the tether tension applied to the underwater robot, it is difficult to relocate the anchors.

As for the robot anchor, the anchor lacks a swimming function but has the ability to run on the sea floor. The robot anchor receives the power supply from the underwater main body through the tether. In this case, it is also possible to transfer part of functions of main body to the robot anchor side.

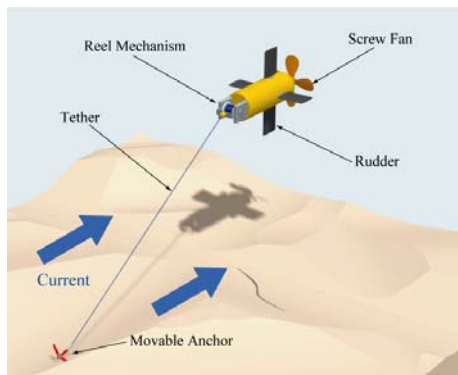

Fig. 1 Concept of tether mooring type underwater robot

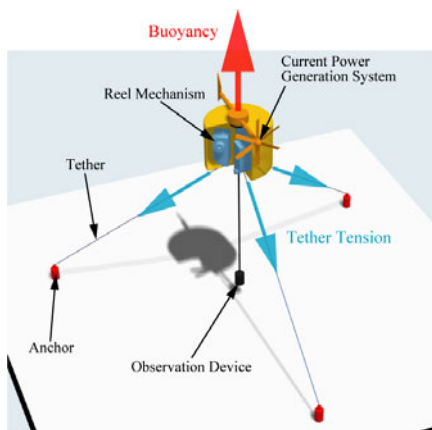

Fig. 2 3-tethers type submarine robot

By combining robot anchor type with multiple tether type, the robot can function as colony robot.

### B. Sea Current Power Generation Mechanism

It can generate electricity for tether mooring type underwater robot, due to the tether moored against current. In the past, submarine robots have been used in a generation system, such as SAUV II [4] that utilise solar power generation. However, in order to generate power, the submarine robot has to float on the surface of the sea to get more sunlight. Thus it may be damaged by waves during bad weather. Also, the weather may greatly influence the amount of electricity generated. The algae which adhere to the surface of the solar cell can significantly reduce the efficiency of generation.

With sea current power generation, only a little current is needed, and there is no need to float up to the surface of the sea (generally the speed of the sea currents on the seabed are very small, thus it still has to float up a little shown in Figure 5). Furthermore, when a solar power generation system is not working, it becomes a needless load. The screw fan type power generation system has the advantage of being a propeller. This research employs the screw fan type sea current power generation system.

	Fixed Anchor	Movable Anchor	Robot Anchor
1-tether Type			
3-tether Type		—	

Fig. 3 Classification of tether mooring type submarine robot

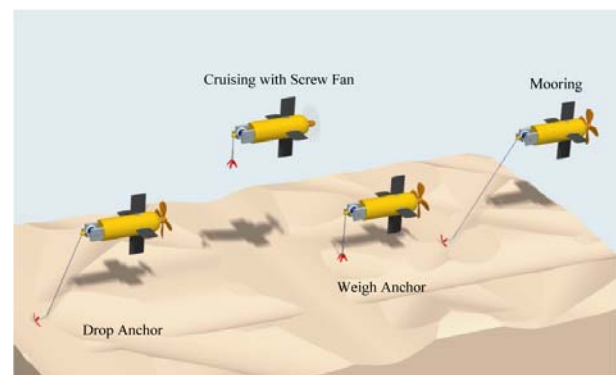

Fig. 4 Use of movable anchor

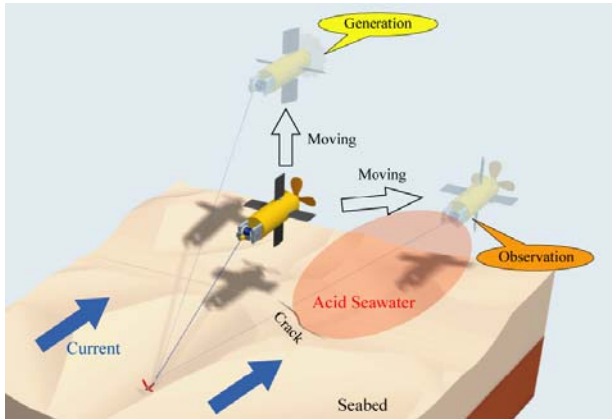

Fig. 5 Operations of tether mooring type underwater robot

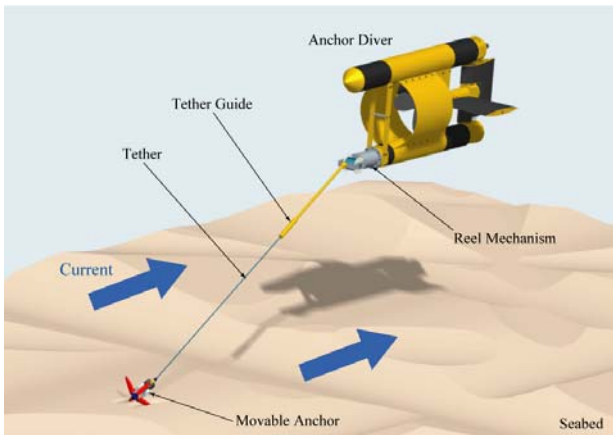

Fig.6 Concept of Anchor Diver

### III. DEVELOPMENT OF PROTOTYPE MODEL “ANCHOR DIVER”

Anchor Diver is developed as a prototype of a tether mooring type underwater robot. Figure 6 shows the concept of Anchor Diver. Anchor Diver is equipped with a screw fan generator. Due to the design of a movable anchor mechanism, the anchor can be pulled back and relocated which expands the range of activities. Considering initial experiments in a relatively shallow river, the total height is designed to be less than 400 mm.

#### A. Main Body Design

The ship has been developed before the development of a reel mechanism. The diameter of the sea current electric generating screw-fan is 200 mm, and the electric generating capacity (Betz limit) [5] is 9W. Figure 7 shows the appearance of the developed Anchor Diver.

The mechanical section of Anchor Diver is shown in Figures 8 and 9: Figure 8 shows the electric generating device and the control mechanism for the horizontal rudder

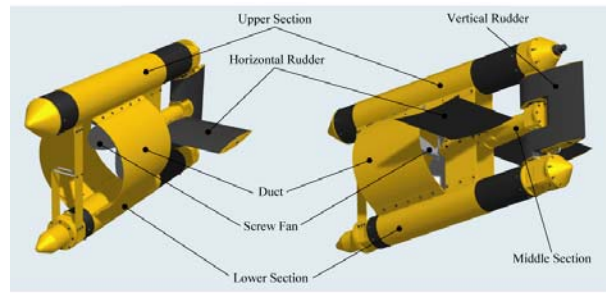

Fig.7 Appearance of Anchor Diver

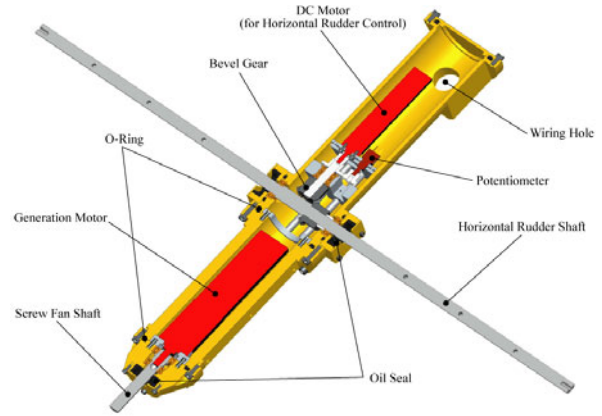

Fig.8 Generator and horizontal rudder control mechanism (Middle section)

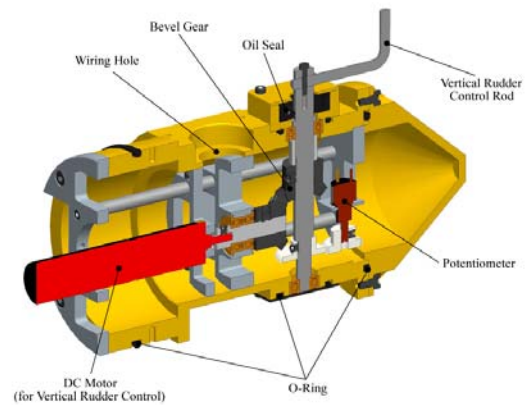

Fig.9 Vertical rudder control mechanism

in middle part of the body; Figure 9 shows the control mechanism for the vertical rudder at the bottom part of the vehicle rear. Each section of the axis of gyration is water-proofed by oil seal as shown in Figure 10.

The robot is designed with positive buoyancy. Table 1 describes the specification of Anchor Diver. It is easy to carry to the experiment spot with total height within 400mm and weight within 10 kg.

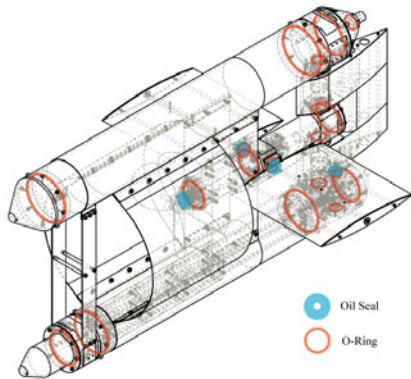

Fig.10 Waterproof structure of Anchor Diver

Table.1 Mechatronics characteristics

Measure (Length×Width×Height)	830mm×484mm×392mm
Displacement	10.6kg
Wight in the air	10.3kg
Diameter of screw fan	196mm
Horizontal rudder angle range	±90deg
Vertical rudder angle range	±45deg

### B. Movable Anchor Design

The movable anchor concept is shown in Figure 11. Considering long-term operation in the water, the movable anchor is designed to move by a simple mechanism, without electricity. Generally, the prongs of the anchor are locked. The lock mechanism is released by the tether guide which is attached in front of the reel mechanism on the main body. The tether goes through the tether guide from the reel mechanism to anchor. When the reel mechanism draws the tether back, the tether become shorter and makes the tether guide press the slide lock block of movable anchor. Figure 12 shows the lock mechanism of movable anchor.

Since the tether goes through the tether guide, it can also be designed to cut off the algae attached on the tether to make reel mechanism operate smoothly.

### IV. Operation Check of Anchor Diver

After the design and manufacture of Anchor Diver, several operational tests were carried out.

#### A. Water-Resistance and Recovery Test

Anchor Diver was placed into a small pool to test the water-resistance. After 6 hours driving of the horizontal rudder, the vertical rudder and the screw fan, we opened the robot and didn't find water inside.

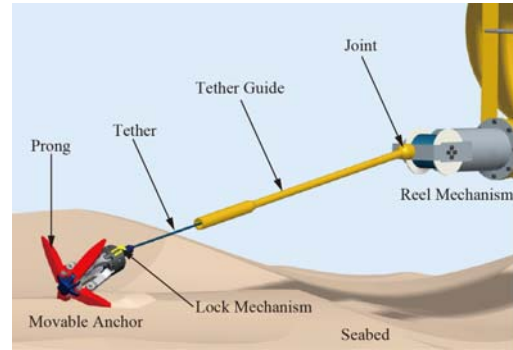

Fig. 11 Concept of Movable Anchor

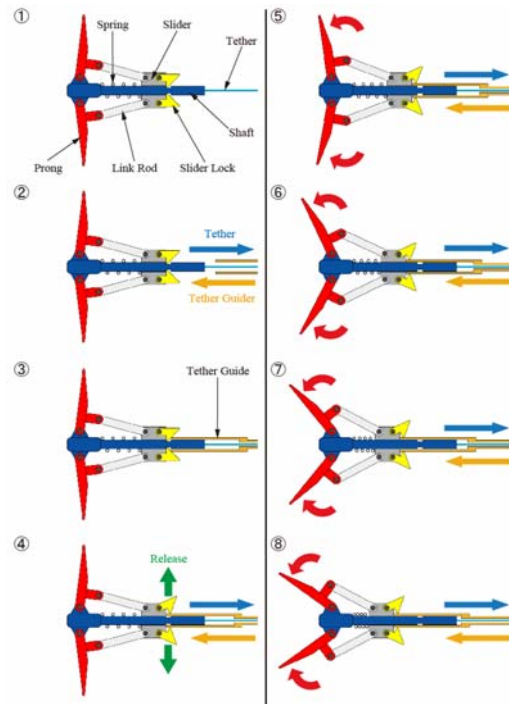

Fig. 12 Lock-release Mechanism of Movable Anchor

Therefore water-resistance was confirmed. Adjustment of the battery pack longitudinal position keeps the ship in trim. The ability to recover from non-upright positions was confirmed by putting the robot upside-down in the water and it moved back to the original state.

#### B. Rudder Operation

Turning motion and diving motion can be implemented by operating the vertical rudder and the horizontal rudder while the screw fan is driving. Figure 13 shows the image of the turning motion and figure 14 shows the image of the diving motion. Further, Figure 15 shows the performance of position control by rudder operation while Anchor diver is pulled by electrical reel.



For concurrent underwater simulation, we used the model shown in Figure 16. The fluid force applied to the ship body of Anchor Diver can be obtained by computer simulation Software SCRYU/Tetra (Cradle, Inc.). Figure 17 shows the relationship between relative flow rate and drag of the ship body. For simplicity of geometry, the ship body model includes a disk with the same projected area as the propeller fan. In Figure 18, the solid red line describes the drag applied to the disk; the dashed red- line describes the drag applied to the propeller fan which is used in the model of sea current power generation. The difference between these two values is small; therefore the disk can substitute for propeller fan.

The change in force applied to the ship's body as the angle is varied for the horizontal rudder ( $F_x$ ) and vertical rudder ( $F_y$ ) is shown in Fig.18 and Fig.19. The results show the possible mobility range of Anchor Diver.

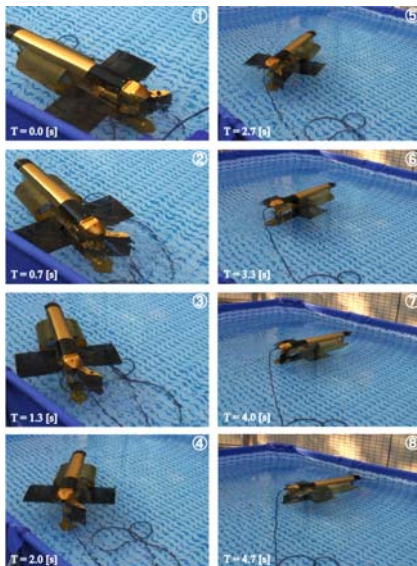

Fig.13 Turning motion of Anchor Diver

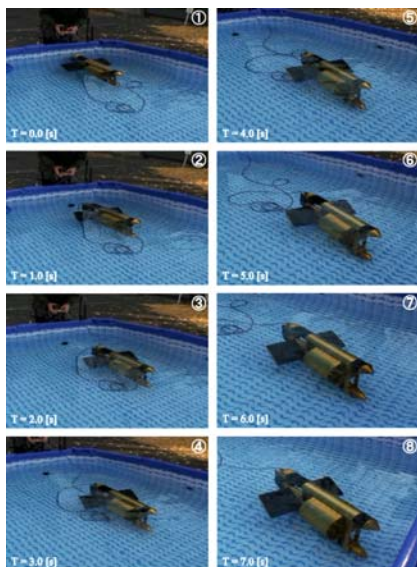

Fig.14 Diving motion of Anchor Diver

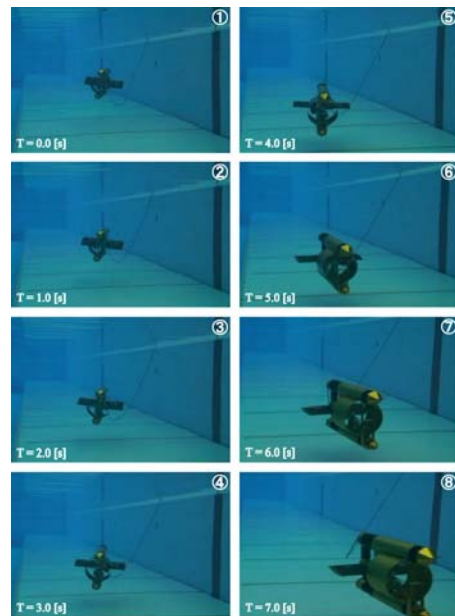

Fig.15 Steering using horizontal and vertical rudder

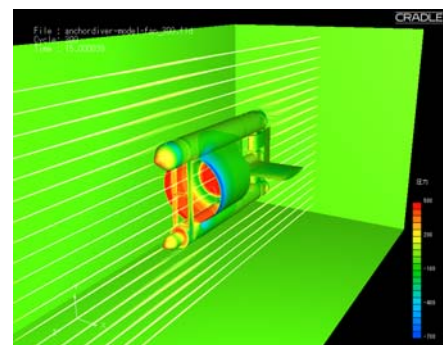

Fig.16 Stream line and pressure contour of Anchor Diver Model

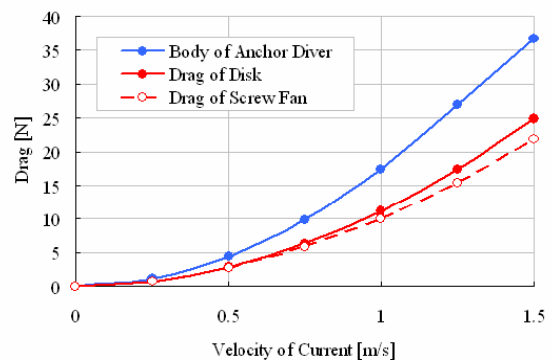

Fig.17 Drag against velocity of current

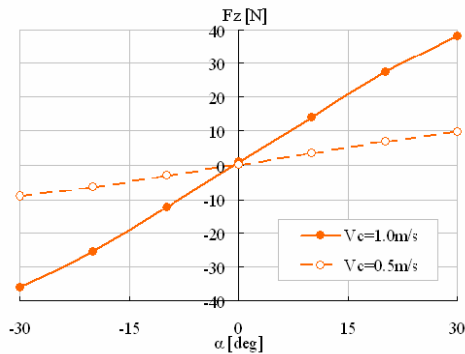

Fig.18 Force against angle of attack  $\alpha$  of horizontal rudder ( $V_c$ : Velocity of sea current)

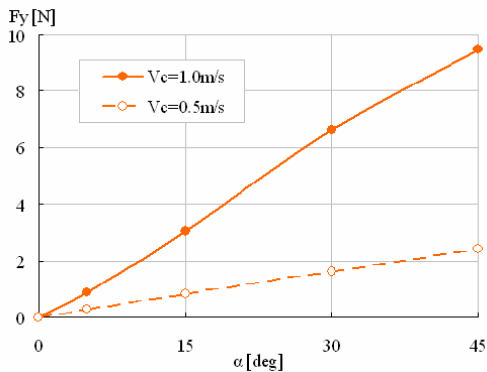

Fig.19 Force against angle of attack  $\alpha$  of vertical rudder

### C. Sea Current Power Generation Results

To confirm the power generation capability of Anchor Diver, a power generation experiment was carried out. The method was to pull Anchor Diver forward by using an electric winch (with a rope attached to the front of Anchor Diver) to generate a relative velocity with the bulk fluid. Here a 10W DC motor with a gear head with 1/16 reduction ratio was connected to the screw fan to be used for power generation.

In order to optimize the power generation performance of Anchor Diver, the first step of the experiment was to change the load of the motor by changing the duty ratio of the PWM. Here the fluid speed was 1.2 m/s and the area of the propeller was 0.03 m<sup>2</sup>. The result of the relation between the load and the electricity generating capacity is shown in Figure 20. The result showed that the maximum power was 1.7 W while the angular velocity of screw fan was 120 rpm. Due to the gear reduction ratio of 1/16, the angular velocity of the motor was around 2000 rpm.

From this experiment, it was proved that there is an optimum load condition for the motor to generate power most efficiently. The next step will be doing more

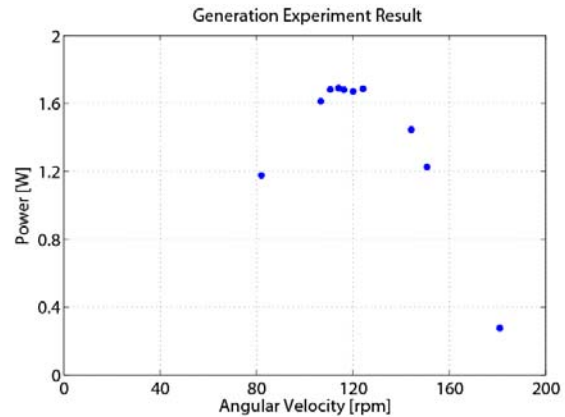

Fig.20 Experimental results of optimization of power generation performance

experiments to collect more data under different sea current speeds. This will allow Anchor Diver to generate power efficiently in all sea conditions.

### V. CONCLUSIONS AND FUTURE WORK

The concept of tether mooring type underwater robot “Anchor Diver” was proposed, and the first model has been built. The mobility and power generation systems of Anchor Diver were evaluated.

The next step will be the development of the reel mechanism and prototype movable anchor. Future work will also include increasing the efficiency of power generation by investigating different shapes for the duct and screw fan. Additionally, an improved sealing method would reduce the friction on the output shaft which is currently caused by the oil seal.

### REFERENCES

- [1] M. Sorai and T. Ohsumi, Ocean uptake potential for carbon dioxide sequestration, *Geochemical Journal*, Vol. 39 (2005), No. 1 pp.29-45
- [2] I. Atsushi, H. Masahiro, K. Jun, III-3. Effects on Adult Fish (III. Effects of CO<sub>2</sub> on Marine Organisms) (CO<sub>2</sub> Ocean Sequestration and its Biological Impacts), *Bulletin of Japanese Society of Scientific Fisheries*, Vol.67(2001), No.4, pp.760-761
- [3] Hirose Shigeo, Mobile vehicles a in air and in water, patent number: 2006-160025, Japan patent office
- [4] Denise M. Crimmins, Christopher T. Patty, Michael A. Beliard, John Baker, James C. Jalbert, Rick J. Komerska, Steven G. Chappell, D. Richard Blidberg, “Long-Endurance Test Results of the Solar-Powered AUV System”, *MTS/IEEE Oceans 2006 Conference*, Sep., 2006.
- [5] Betz, A. (1966) *Introduction to the Theory of Flow Machines*. (D. G. Randall, Trans.) Oxford: Pergamon Press.